

S32F-16

三节式隐藏反弹同步滑轨(16板)

SYNCHRONIZED FULL EXTENSION PUSH TO OPEN UNDERMOUNTED SLIDE

载重: 35公斤 Load capacity: 35Kg
 长度: 250-550mm Length: 250-550mm
 抽屉高度调节量0~+3mm Drawer height adjustment: 0~+3mm
 抽屉左右调节量±1.5mm Drawer width adjustment: ±1.5mm



滑轨安装尺寸 Installation dimensions

SKW=抽屉内宽度 Internal drawer width
 LW=柜内宽度 Internal cabinet width
 NL=滑轨标称长度 Slide length
 LT=柜内深度 Internal cabinet depth
 抽屉尺寸和钻孔 Drawer size and boring
 侧板最大厚度: 16mm Max drawerside thickness: 16mm

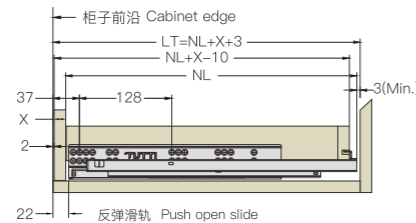
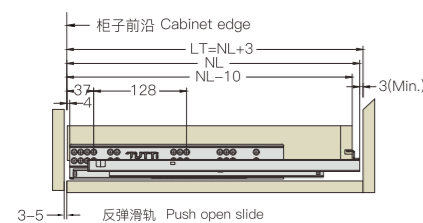
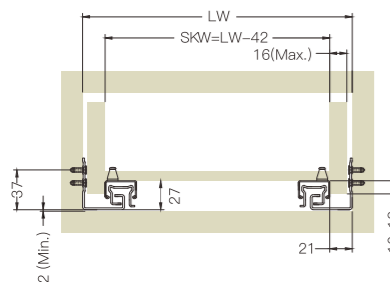

外置抽屉 Standard drawer

内置抽屉 Internal drawer

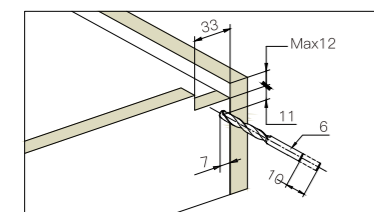

抽屉尺寸和钻孔(mm) Drawer size and drilling

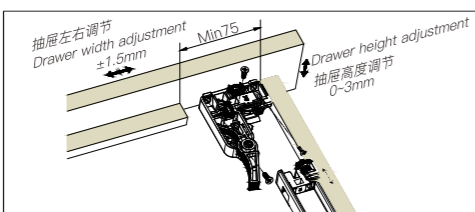

滑轨安装孔位 Hole position

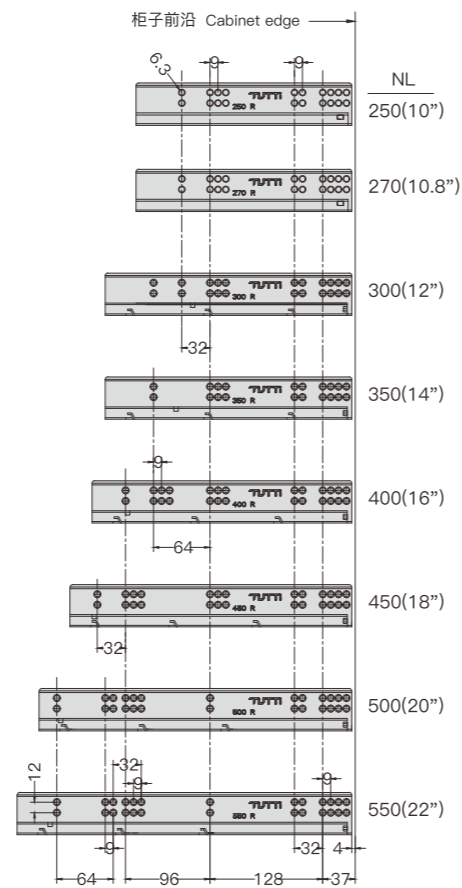

S32F-18

三节式隐藏反弹同步滑轨(18板)

SYNCHRONIZED FULL EXTENSION PUSH TO OPEN UNDERMOUNTED SLIDE

载重: 35公斤 Load capacity: 35Kg
 长度: 250-550mm Length: 250-550mm
 抽屉高度调节量0~+3mm Drawer height adjustment: 0~+3mm
 抽屉左右调节量±1.5mm Drawer width adjustment: ±1.5mm



滑轨安装尺寸 Installation dimensions

SKW=抽屉内宽度 Internal drawer width
 LW=柜内宽度 Internal cabinet width
 NL=滑轨标称长度 Slide length
 LT=柜内深度 Internal cabinet depth
 抽屉尺寸和钻孔 Drawer size and boring
 侧板最大厚度: 19mm Max drawerside thickness: 19mm

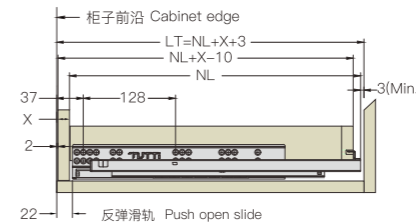
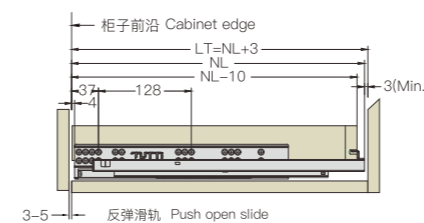
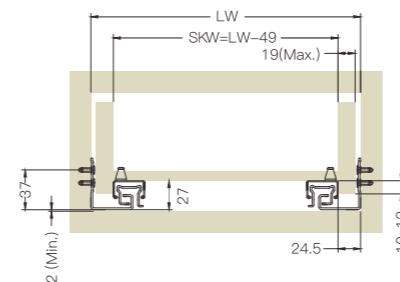

外置抽屉 Standard drawer

内置抽屉 Internal drawer

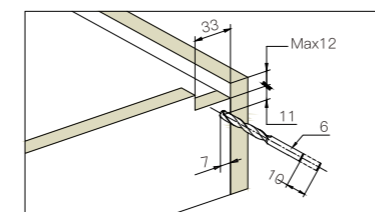

抽屉尺寸和钻孔(mm) Drawer size and drilling

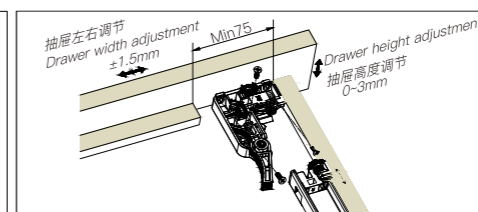

滑轨安装孔位 Hole position

